

DORMER  PRAMET

TOOL BITS

2023



 **DORMER**

GL GROOVING AND PARTING-OFF

Explore our complete GL Brochure, newly Featuring Tools with High-Pressure Internal Cooling, Internal grooving tools, Axial Grooving Tools, Single sided inserts for deep parting-off and many more.



DORMER PRAMET

NEW PRODUCTS
GL GROOVING AND PARTING-OFF 2023.2

PRAMET



HSS-E Rectangular Tool bit

Ground rectangular tool bit according to DIN 4964 D standard. T2000S HSS-E bright steel with 10% Cobalt content in hardness 65-67 HRC.

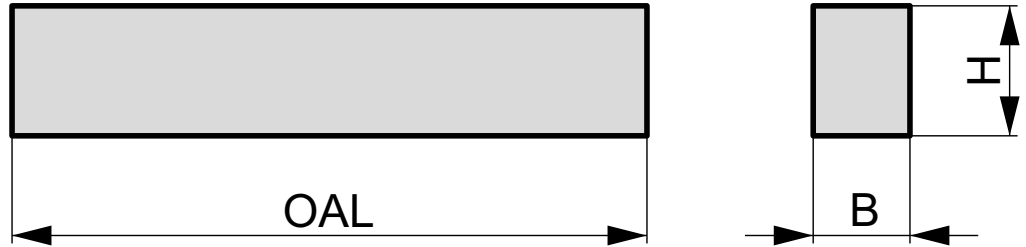

HSS-E	DIN 4964D	Bright
h13		

Product	H (mm)	B (mm)	OAL (mm)
8X6X200:T2000S	8	6	200
10X2X200:T2000S	10	2	200
10X3X200:T2000S	10	3	200
10X4X200:T2000S	10	4	200
10X5X200:T2000S	10	5	200
10X6X200:T2000S	10	6	200
10X8X200:T2000S	10	8	200
12X3X200:T2000S	12	3	200
12X4X200:T2000S	12	4	200
12X6X200:T2000S	12	6	200
12X8X200:T2000S	12	8	200
15X3X200:T2000S	15	3	200
15X4X200:T2000S	15	4	200
15X5X200:T2000S	15	5	200
15X6X200:T2000S	15	6	200
15X8X200:T2000S	15	8	200
15X10X200:T2000S	15	10	200
16X8X200:T2000S	16	8	200
16X10X200:T2000S	16	10	200

Product	H (mm)	B (mm)	OAL (mm)
16X12X200:T2000S	16	12	200
20X3X200:T2000S	20	3	200
20X4X200:T2000S	20	4	200
20X5X200:T2000S	20	5	200
20X6X200:T2000S	20	6	200
20X8X200:T2000S	20	8	200
20X10X200:T2000S	20	10	200
20X12X200:T2000S	20	12	200
20X15X200:T2000S	20	15	200
25X5X200:T2000S	25	5	200
25X6X200:T2000S	25	6	200
25X10X200:T2000S	25	10	200
25X12X200:T2000S	25	12	200
30X4X200:T2000S	30	4	200
30X5X200:T2000S	30	5	200
30X10X200:T2000S	30	10	200
30X15X200:T2000S	30	15	200
30X20X200:T2000S	30	20	200

TOOL BITS R



HSS-E Round Tool bit

Ground round tool bit according to DIN 4964 A standard. T2000S HSS-E bright steel with 10% Cobalt content in hardness 65-67 HRC.

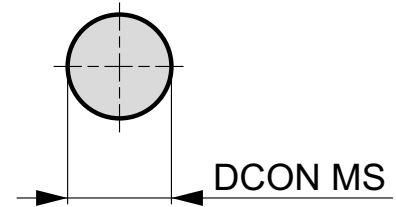
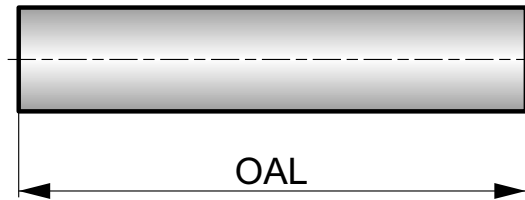

HSS-E	DIN 4964A	Bright
h9		

Product	DCON MS	OAL
	(mm)	(mm)
3X200 T:T2000S	3	200
4X200 T:T2000S	4	200
5X200 T:T2000S	5	200
6X200 T:T2000S	6	200
7X200 T:T2000S	7	200
8X200 T:T2000S	8	200
10X200 T:T2000S	10	200
12X200 T:T2000S	12	200
14X200 T:T2000S	14	200
16X200 T:T2000S	16	200
20X200 T:T2000S	20	200

TOOL BITS S



HSS-E Square Tool bit

Ground square tool bit according to DIN 4964 B standard. T2000S HSS-E bright steel with 10% Cobalt content in hardness 65-67 HRC.

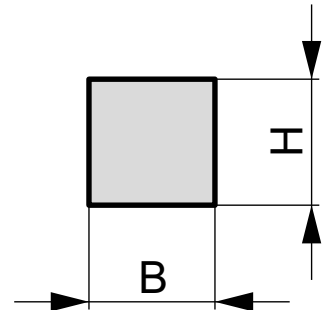
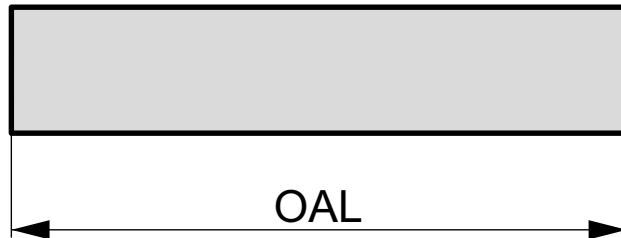

HSS-E

DIN
4964B



+0
-0.1

Product	H (mm)	B (mm)	OAL (mm)
4X4X200:T2000S	4	4	200
6X6X200:T2000S	6	6	200
8X8X200:T2000S	8	8	200
10X10X200:T2000S	10	10	200
12X12X200:T2000S	12	12	200
14X14X200:T2000S	14	14	200
15X15X200:T2000S	15	15	200
16X16X200:T2000S	16	16	200
20X20X200:T2000S	20	20	200
25X25X200:T2000S	25	25	200

TOOL BITS SA



HSS-E Square Tool bit with Bevel

Ground square tool bit with beveled ends according to DIN 4964 B standard. T2000S HSS-E bright steel with 10% Cobalt content in hardness 65-67 HRC.

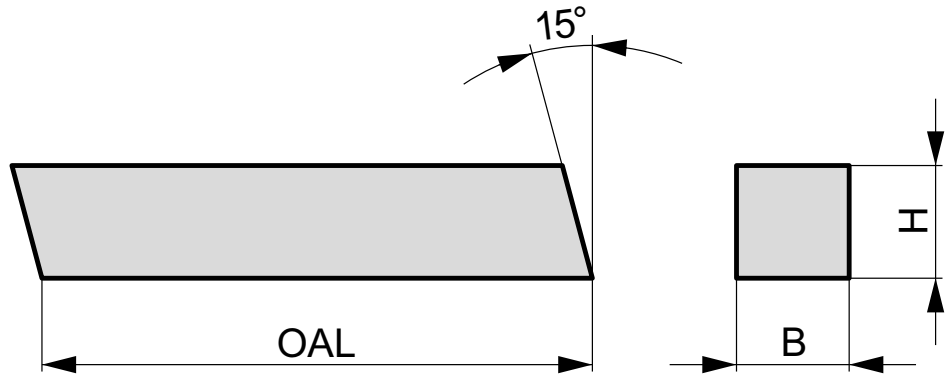

HSS-E	DIN 4964B	Bright
h13		

Product	H	B	OAL	H	B	OAL
	(mm)	(mm)	(mm)	(inch)	(inch)	(inch)
4X4X200A:T2000S	4	4	200	—	—	—
6X6X100A:T2000S	6	6	100	—	—	—
6X6X200A:T2000S	6	6	200	—	—	—
8X8X100A:T2000S	8	8	100	—	—	—
8X8X160A:T2000S	8	8	160	—	—	—
8X8X200A:T2000S	8	8	200	—	—	—
10X10X100A:T2000S	10	10	100	—	—	—
10X10X160A:T2000S	10	10	160	—	—	—
10X10X200A:T2000S	10	10	200	—	—	—
12X12X100A:T2000S	12	12	100	—	—	—
12X12X200A:T2000S	12	12	200	—	—	—
14X14X200A:T2000S	14	14	200	—	—	—
15X15X200A:T2000S	15	15	200	—	—	—
16X16X200A:T2000S	16	16	200	—	—	—
20X20X200A:T2000S	20	20	200	—	—	—
25X25X200A:T2000S	25	25	200	—	—	—
3/16X3/16X2.1/2A:T2000S	—	—	—	3/16	3/16	2.500
1/4X1/4X2.1/2A:T2000S	—	—	—	1/4	1/4	2.500
1/4X1/4X4A:T2000S	—	—	—	1/4	1/4	4.000
5/16X5/16X2.1/2A:T2000S	—	—	—	5/16	5/16	2.500
5/16X5/16X4A:T2000S	—	—	—	5/16	5/16	4.000
3/8X3/8X3A:T2000S	—	—	—	3/8	3/8	3.000
3/8X3/8X4A:T2000S	—	—	—	3/8	3/8	4.000
3/8X3/8X6A:T2000S	—	—	—	3/8	3/8	6.000
1/2X1/2X4A:T2000S	—	—	—	1/2	1/2	4.000
1/2X1/2X6A:T2000S	—	—	—	1/2	1/2	6.000
5/8X5/8X6A:T2000S	—	—	—	5/8	5/8	4.000

DORMER PRAMET

FOLLOW US

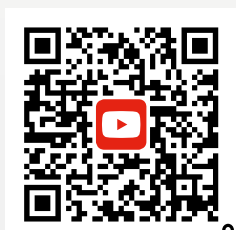

SHARE



LIKE



COMMENT



TAG



RE-TWEET



SIMPLY RELIABLE

As a professional you can judge the quality of work by just looking at the chip. Our chip is a clean and uncomplicated shape that in itself tells a story. It is a clear and consistent signal and that's why we use it as a symbol for being **Simply Reliable**.

DORMER PRAMET

www.dormerpramet.com



**CONTACTS TO LOCAL
SALES SUPPORT
ALWAYS UP TO DATE!**



PRA-BRO-TOOLBITS-2023-EN

FOLLOW US...



ONLINE



SEGMENTS



LIBRARY APP.



CALCULATOR APP.

